

# JFET-Input Operational Amplifiers

## Low Supply Current (LF155)

## High-Speed (LF156)

### FEATURES

- *Guaranteed* Offset Voltage Drift on All Grades
- *Guaranteed* Slew Rate on All Grades
- *Guaranteed* Low Input Offset Current      10pA Max.
- *Guaranteed* Low Input Bias Current      50pA Max.
- *Guaranteed* High Slew Rate (156A/356A) 10V/ $\mu$ s Min.
- Fast Settling to 0.01%      1.5 $\mu$ s

### APPLICATIONS

- Output Amplifiers for D/A Converters
- Fast Sample and Hold Circuits
- High Speed Integrators
- Photocell Amplifiers
- High Input Impedance Buffers

### DESCRIPTION

Linear Technology's LF155/156 series features several improvements compared to similar types from other manufacturers: offset voltage drift with temperature and slew rate are guaranteed on all grades, not just on the more expensive "A" grades. Other specifications such as voltage gain and high temperature bias and offset currents are also improved.

The industry standard LF155/156 devices exhibit phase reversal at the output when the negative common-mode limit at the input is exceeded (i.e., from  $-12V$  to  $-15V$  with  $\pm 15V$  supplies). This can cause lock-up in servo systems. As shown below, Linear Technology's LF155/156 does not have this problem due to unique phase reversal protection circuitry. For applications requiring higher performance, see the LT1055 and LT1056 data sheets.

**2**

**Voltage Follower with Input Exceeding the Negative Common-Mode Range**

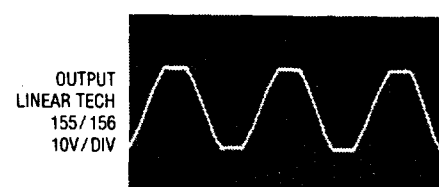
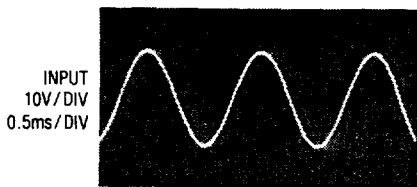
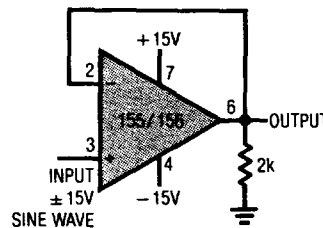

# LF155A/355A/155/355 LF156A/356A/156/356

## ABSOLUTE MAXIMUM RATINGS

### Supply Voltage

LF155A/155/355A, LF156A/156/356A .....	±22V
LF355/356 .....	±18V

### Differential Input Voltage

LF155A/155/156A/156 .....	±40V
LF355A/355/356A/356 .....	±30V

### Input Voltage (Note 1)

LF155A/155/156A/156 .....	±20V
LF355A/355/356A/356 .....	±16V

### Output Short Circuit Duration .....

Indefinite

### Operating Temperature Range

LF155A/155/156A/156 .....	-55°C to 125°C
LF355A/355/356A/356 .....	0°C to 70°C

### Maximum Junction Temperature

LF155A/155/156A/156 .....	150°C
LF355A/355/356A/356 .....	100°C

### Storage Temperature Range

All Devices .....

Lead Temperature (Soldering, 10 sec.) .....

## PACKAGE/ORDER INFORMATION

TOP VIEW		ORDER PART NUMBER	
<p>H PACKAGE METAL CAN</p>		LF155H	LF156H
		LF155AH	LF156AH
		LF355H	LF356H
		LF355AH	LF356AH
<p>N8 PACKAGE 8 PIN PLASTIC</p>		LF355N8	LF356N8
		LF355AN8	LF356AN8
		$V_{OS}$ is adjusted with a 20k or 50k potentiometer between the balance terminals. The wiper is tied to $V^+$	

## ELECTRICAL CHARACTERISTICS (Note 2)

SYMBOL	PARAMETER	CONDITIONS	LF155A/156A LF355A/356A			LF155/156			LF355/356			UNITS
			MIN	TYP	MAX	MIN	TYP	MAX	MIN	TYP	MAX	
$V_{OS}$	Input Offset Voltage	$T_A = 25^\circ\text{C}$ Over Temperature	1	2	2.5	2	3.5	4.8	3	8	9	mV
$\frac{\Delta V_{OS}}{\Delta T}$	Average TC of Input Offset Voltage	$R_S = 50\Omega$	3	5	2.3	5	15		5	25		$\mu\text{V}/^\circ\text{C}$
	Change in Average TC with $V_{OS}$ Adjust	$R_S = 50\Omega$ (Note 4)		0.5		0.5			0.5			$\mu\text{V}/^\circ\text{C}$ per mV
$I_{OS}$	Input Offset Current	$T_J = 25^\circ\text{C}$ (Note 3) $T_J \leq 125^\circ\text{C}$ $T_J \leq 70^\circ\text{C}$	3	10	9	3	20	9	3	50	—	pA
				0.7			—			1.5		nA
$I_B$	Input Bias Current	$T_J = 25^\circ\text{C}$ (Note 3) $T_J \leq 125^\circ\text{C}$ $T_J \leq 70^\circ\text{C}$	30	50	15	30	100	15	30	200	—	pA
				0.9			—			3.0		nA
$R_{IN}$	Input Resistance	$T_J = 25^\circ\text{C}$	$10^{12}$			$10^{12}$			$10^{12}$			$\Omega$
$A_{VOL}$	Large Signal Voltage Gain	$V_S = \pm 15\text{V}$ , $T_A = 25^\circ\text{C}$ , $V_O = \pm 10\text{V}$ , $R_L = 2\text{k}$ Over Temperature	75	200	30	50	200	25	40	200	25	V/mV
												V/mV

**ELECTRICAL CHARACTERISTICS** (Note 2)

SYMBOL	PARAMETER	CONDITIONS	LF155A/156A LF355A/356A			LF155/156			LF355/356			UNITS
			MIN	TYP	MAX	MIN	TYP	MAX	MIN	TYP	MAX	
V <sub>O</sub>	Output Voltage Swing	V <sub>S</sub> = ±15V, R <sub>L</sub> = 10k	● ±12	±13		±12	±13		±12	±13		V
		V <sub>S</sub> = ±15V, R <sub>L</sub> = 2k	● ±10	±12		±10	±12		±10	±12		V
V <sub>CM</sub>	Input Common-Mode Voltage Range	V <sub>S</sub> = ±15V	● ±11	+15.1 -12		±11	+15.1 -12		±10	±15.1 -12		V
CMRR	Common-Mode Rejection Ratio		● .85	100		85	100		80	100		dB
PSRR	Supply Voltage Rejection Ratio	V <sub>S</sub> = ±10V to ±18V	● 85	100		85	100		—	—		dB
		V <sub>S</sub> = ±10V to ±15V	● —	—		—	—		80	100		dB
I <sub>S</sub>	Supply Current	T <sub>A</sub> = 25°C, V <sub>S</sub> = ±15V LF155/355 Series LF156/356 Series LF356A		2	4		2	4		2	4	mA
				5	7		5	7		5	10	mA
				5	7		—	—		—	—	
SR	Slew Rate	A <sub>V</sub> = +1 T <sub>A</sub> = 25°C, V <sub>S</sub> = ±15V LF155/355 Series LF156/356 Series		5	7		5	7		2.5	6	V/μs
				10	12		9	12		4	12	V/μs
GBW	Gain Bandwidth Product	T <sub>A</sub> = 25°C, V <sub>S</sub> = ±15V LF155/355 Series LF156/356 Series		—	2.5		2.5			2.5		MHz
				4	5		5			5		MHz
t <sub>S</sub>	Settling Time to 0.01%	T <sub>A</sub> = 25°C, V <sub>S</sub> = ±15V LF155 Series (Note 5) LF156 Series		4			4			4		μs
				1.5			1.5			1.5		μs
e <sub>n</sub>	Input Noise Voltage Density	T <sub>A</sub> = 25°C, V <sub>S</sub> = ±15V f = 100Hz LF155 Series LF156 Series		25			25			25		nV/√Hz
				15			15			15		nV/√Hz
				20			20			20		nV/√Hz
i <sub>n</sub>	Input Noise Current Density	T <sub>A</sub> = 25°C, V <sub>S</sub> = ±15V f = 100Hz f = 1000Hz		0.01			0.01			0.01		pA/√Hz
				0.01			0.01			0.01		pA/√Hz
C <sub>IN</sub>	Input Capacitance		● 3			3			3		pF	

2

The ● denotes the specifications which apply over the full operating temperature range. The shaded electrical specifications indicate those parameters which have been improved or guaranteed test limits provided for the first time.

For MIL-STD components, please refer to LTC 883C data sheet for test listing and parameters.

**Note 1:** Unless otherwise specified, the absolute maximum negative input voltage is equal to the negative power supply voltage.

**Note 2:** Unless otherwise stated, these test conditions apply:

	LF155A/156A LF155/156	LF355A/356A	LF355/356
Supply Voltage, V <sub>S</sub>	±15V ≤ V <sub>S</sub> ≤ ±20V	±15V ≤ V <sub>S</sub> ≤ ±18V	V <sub>S</sub> = ±15V
T <sub>A</sub>	-55°C ≤ T <sub>A</sub> ≤ +125°C	0°C ≤ T <sub>A</sub> ≤ +70°C	0°C ≤ T <sub>A</sub> ≤ +70°C

and V<sub>OS</sub>, I<sub>B</sub> and I<sub>OS</sub> are measured at V<sub>CM</sub> = 0.

**Note 3:** The input bias currents are junction leakage currents which approximately double for every 10°C increase in the junction temperature, T<sub>J</sub>. Due to limited production test time, the input bias currents measured are correlated to junction temperature. In normal operation the junction temperature rises above the ambient temperature as a result of internal power dissipation, P<sub>D</sub>. T<sub>J</sub> = T<sub>A</sub> + Θ<sub>JA</sub> P<sub>D</sub> where Θ<sub>JA</sub> is the thermal resistance from junction to ambient. Use of a heat sink is recommended if input bias current is to be kept to a minimum.

**Note 4:** The temperature coefficient of the adjusted input offset voltage changes only a small amount (0.5μV/°C typically) for each mV of adjustment from its original unadjusted value. Common-mode rejection and open loop voltage gain are also unaffected by offset adjustment.

**Note 5:** Settling time is defined here for a unity gain inverter connection using 2kΩ resistors. It is the time required for the error voltage (the voltage at the inverting input pin on the amplifier) to settle to within 0.01% of its final value from the time a 10V step input is applied to the inverter.

## TYPICAL PERFORMANCE CHARACTERISTICS

Gain, Phase vs Frequency

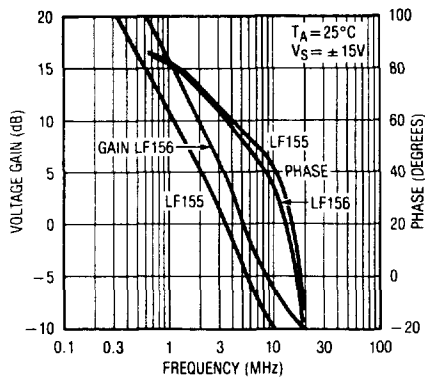

Inverter Settling Time

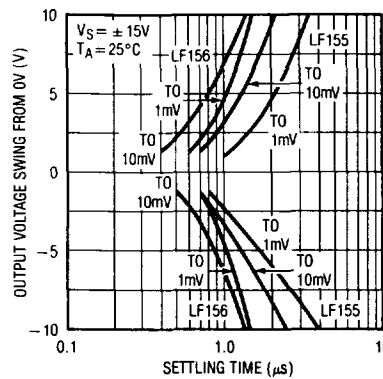

Normalized Slew Rate vs Temperature

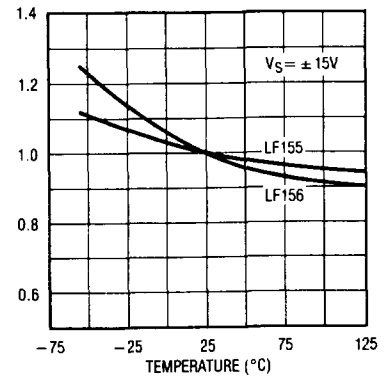

Supply Current vs Temperature

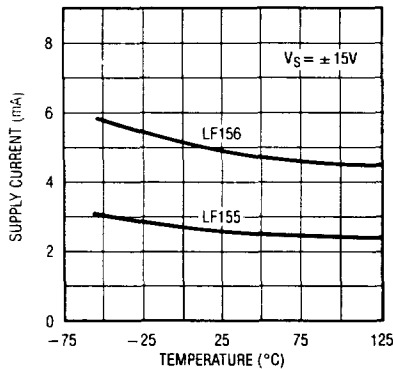

LF156 Large Signal Response

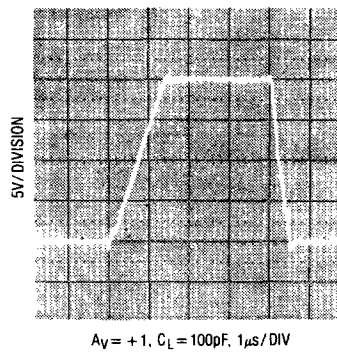

LF156 Small Signal Response

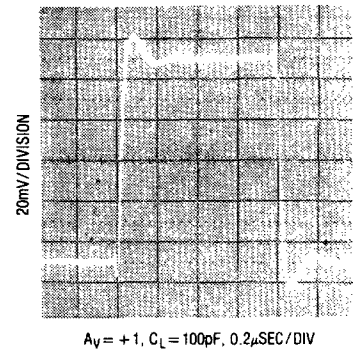

## PACKAGE DESCRIPTION Dimensions in inches (millimeters) unless otherwise noted.

H Package Metal Can

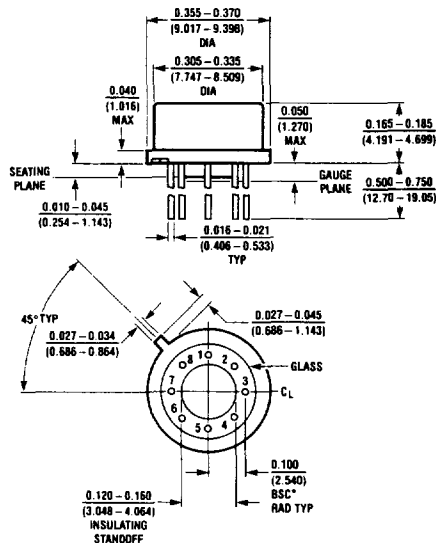

$T_{jmax}$	$\theta_{ja}$	$\theta_{jc}$
150°C	150°C/W	45°C/W

N8 Package 8 Lead Plastic

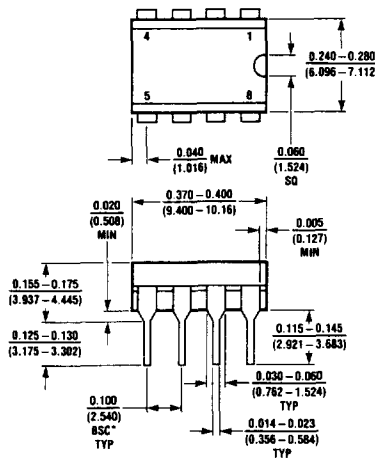

\*LEADS WITHIN 0.007 OF TRUE POSITION (TP) AT GAUGE PLANE

$T_{jmax}$	$\theta_{ja}$
100°C	130°C/W